

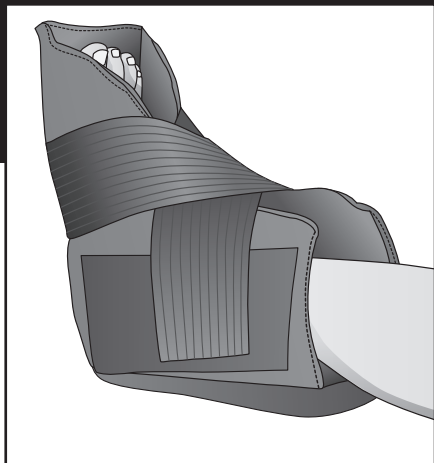

PRUVENTOR™

Single Patient Use Only

RX Only



IMPORTANT INFORMATION

Please read all instructions, warnings, and precautions before use. Correct application is essential for proper functioning of product.

INTENDED USE

The PRUventor™ is intended for patients at risk of developing heel decubitus ulcers. The PRUventor™ also helps prevent foot drop and foot rotation.

CONTRAINDICATIONS

The PRUventor™ is not recommended for patients with severe foot drop, severe ankle contractures and severe spasticity.

WARNINGS

- DO NOT allow patient to stand or walk while wearing.
- Periodically remove PRUventor™ to assess skin according to hospital policies and procedures.

PRECAUTIONS

This product is to be fitted by a physician (or properly licensed practitioner) who is familiar with the purpose for which they are responsible. The physician or practitioner is responsible for providing wearing instructions and precautions to other healthcare practitioners or healthcare providers involved in the patient's care as well as the patient. Consult your physician (or

properly licensed practitioner) immediately if you experience sensation changes, unusual reactions, swelling or increased pain while using this product. Follow the instructions of your physician (or properly licensed practitioner) for length and duration of use.

INSTRUCTIONS FOR USE

1. Release all hook and loop closures.
2. Gently place the patient's foot into the boot making sure the heel is placed over the heel opening.
3. Take one strap and bring it over the top of the foot and secure the hook tab to the loop on the opposite side of the boot. Take the opposite strap and cross it over the first strap and secure the hook tab to the loop.
4. Pull the foot flaps up to ensure the foot is secure inside the boot.

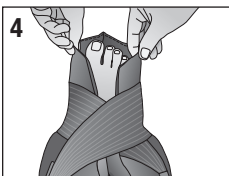
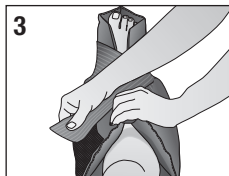
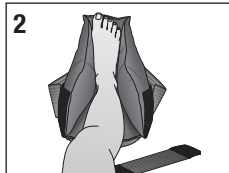
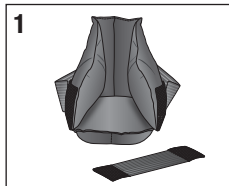

PRUVENTOR™

Single Patient Use Only

RX Only

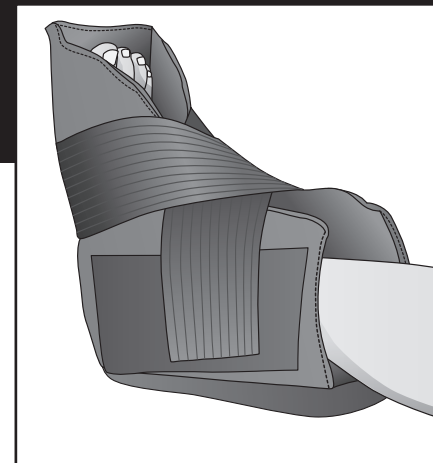

IMPORTANT INFORMATION

Please read all instructions, warnings, and precautions before use. Correct application is essential for proper functioning of product.

INTENDED USE

The PRUventor™ is intended for patients at risk of developing heel decubitus ulcers. The PRUventor™ also helps prevent foot drop and foot rotation.

CONTRAINDICATIONS

The PRUventor™ is not recommended for patients with severe foot drop, severe ankle contractures and severe spasticity.

WARNINGS

- DO NOT allow patient to stand or walk while wearing.
- Periodically remove PRUventor™ to assess skin according to hospital policies and procedures.

PRECAUTIONS

This product is to be fitted by a physician (or properly licensed practitioner) who is familiar with the purpose for which they are responsible. The physician or practitioner is responsible for providing wearing instructions and precautions to other healthcare practitioners or healthcare providers involved in the patient's care as well as the patient. Consult your physician (or

properly licensed practitioner) immediately if you experience sensation changes, unusual reactions, swelling or increased pain while using this product. Follow the instructions of your physician (or properly licensed practitioner) for length and duration of use.

INSTRUCTIONS FOR USE

1. Release all hook and loop closures.
2. Gently place the patient's foot into the boot making sure the heel is placed over the heel opening.
3. Take one strap and bring it over the top of the foot and secure the hook tab to the loop on the opposite side of the boot. Take the opposite strap and cross it over the first strap and secure the hook tab to the loop.
4. Pull the foot flaps up to ensure the foot is secure inside the boot.

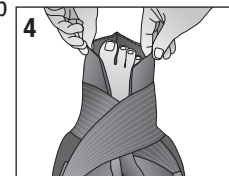
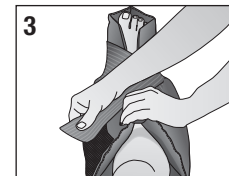
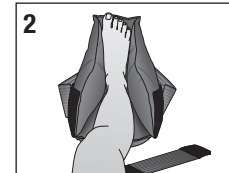
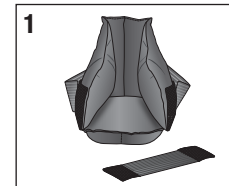



5. If using PRUventor™ Long, apply the leg strap and secure hook tabs to the loop on both sides of the boot.



NOTE: Not applicable for PRUventor™ Short.

6. Apply the anti-rotation wedge by attaching the hook side of the wedge to the exterior, lateral side of the boot. Make sure the bottom of the wedge sits flat on the surface of the bed.

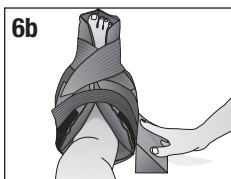
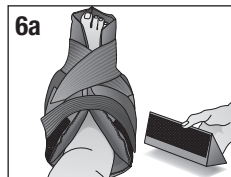

7. Visually check periodically to ensure the heel is suspended over the heel opening. If not, remove the boot and reapply as necessary.
8. If the PRUventor™ is used with sequential or intermittent compression devices, make sure tubing is not bent and is not in contact with the patient's skin. Tubing should exit through the nearest available port. **DO NOT** use the heel opening as an exit for tubing.

You can also find instructional videos on our website at www.deroyal.com.

CARE INSTRUCTIONS

PRUventor™ can be wiped clean with a damp cloth and mild disinfectant. Make sure the product is completely dry before reapplying. Please refer to hospital cleaning procedures.

WARRANTY

DEROYAL PRODUCTS ARE WARRANTED FOR NINETY (90) DAYS FROM THE DATE OF SHIPMENT FROM DEROYAL AS TO PRODUCT QUALITY AND WORKMANSHIP. DEROYAL'S WRITTEN WARRANTIES ARE GIVEN IN LIEU OF ANY IMPLIED WARRANTIES, INCLUDING WARRANTIES OF MERCHANTABILITY OR FITNESS FOR A PARTICULAR PURPOSE.



Improving Care. Improving Business.

Manufacturer
DeRoyal Industries, Inc.
200 DeBusk Lane
Powell, TN 37849 U.S.A.
888.938.7828 • 865.938.7828

©2012 DeRoyal. All Rights Reserved.
Part #0-1856 Revised 1/12



5. If using PRUventor™ Long, apply the leg strap and secure hook tabs to the loop on both sides of the boot.

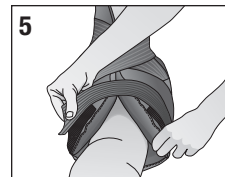

NOTE: Not applicable for PRUventor™ Short.

6. Apply the anti-rotation wedge by attaching the hook side of the wedge to the exterior, lateral side of the boot. Make sure the bottom of the wedge sits flat on the surface of the bed.

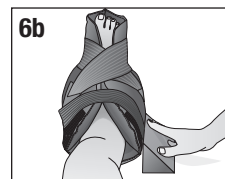
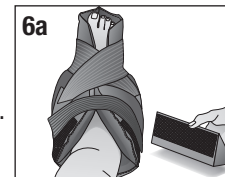

7. Visually check periodically to ensure the heel is suspended over the heel opening. If not, remove the boot and reapply as necessary.
8. If the PRUventor™ is used with sequential or intermittent compression devices, make sure tubing is not bent and is not in contact with the patient's skin. Tubing should exit through the nearest available port. **DO NOT** use the heel opening as an exit for tubing.

You can also find instructional videos on our website at www.deroyal.com.

CARE INSTRUCTIONS

PRUventor™ can be wiped clean with a damp cloth and mild disinfectant. Make sure the product is completely dry before reapplying. Please refer to hospital cleaning procedures.

WARRANTY

DEROYAL PRODUCTS ARE WARRANTED FOR NINETY (90) DAYS FROM THE DATE OF SHIPMENT FROM DEROYAL AS TO PRODUCT QUALITY AND WORKMANSHIP. DEROYAL'S WRITTEN WARRANTIES ARE GIVEN IN LIEU OF ANY IMPLIED WARRANTIES, INCLUDING WARRANTIES OF MERCHANTABILITY OR FITNESS FOR A PARTICULAR PURPOSE.



Improving Care. Improving Business.

Manufacturer
DeRoyal Industries, Inc.
200 DeBusk Lane
Powell, TN 37849 U.S.A.
888.938.7828 • 865.938.7828

©2012 DeRoyal. All Rights Reserved.
Part #0-1856 Revised 1/12